

工學碩士 學位論文

圓管內 海水凍結舉動
實驗的 研究

An Experimental Study on Sea Water Freezing
Behavior in a Cooled Circular Tube

指導教授 吳 喆

2000年 2月

韓國海洋大學校 大學院

機 關 工 學 科

朴 鍾 德

本 論 文 朴 鍾 德 工 學 碩 士 學 位 論 文 認 准

主 審 金 京 根 (印)

委 員 尹 錫 勳 (印)

委 員 吳 喆 (印)

1999年 12月 24日

韓 國 海 洋 大 學 校 大 學 院

機 關 工 學 科 朴 鍾 德

Abstract	
.....	
1	
1.1	1
1.2	10
1.2.1	10
1.2.1.1	10
1.2.1.2	13
1.2.2	15
1.3	17
2	
2.1	18

2.2	24
3		
3.1	30
3.2	39
3.3	50
3.4	61
3.5	67
4	69
	70
	72
	76

Abstract

Everyone knows that water is the most important thing to make our living. However in Korea, many expert organizations have predicted that it will also become water deficiency in the near future.

As becoming generally known, the most effective method is to desalinate the sea water in order to obtain the fresh water. In this present, there are various methods for the desalination of sea water. But the most considerable point for adopting the desalination system is the production cost of fresh-water based on an energy source which should be obtained easily and cheaply. Recently in Korea, the demand of Liquefied Natural Gas (LNG), as a cheap and clean energy which does not cause an environmental problem, is greatly being increased. In general, we put this LNG in storage as a liquid state at below -162 in a tank. When the LNG transforms to the gaseous state at high pressure, it absorbs energy from a heat source. In this process, a large amount of cold energy is wasted. Therefore, we focused to make the desalination system by utilizing this wasted cold

energy. In characteristic point of sea water, high concentration of aqueous solution becomes an eduction from frozen surface in case it frozen over. Therefore, it is possible to desalinize from sea water.

First of all, we have to reveal the freezing mechanism of sea water so as to make the desalination system. The goal of this study is to measure the freezing quantity and freezing rate, and to investigate the freezing heat-transfer characteristics in a Circular Tube. The experimental results will help to provide a general understanding of the sea water freezing behavior to reach completion of the desalination system in the future.

C_i	:		[‰]
F_o	:	Fourie	
H_o	:		[m]
R_f	:		
T_f	:		[]
T_i	:		[]
T_o	:		[]
T_w	:		[]
V_f	:		[m ³ /m ²]
X	:		[mm]
	:		[m ² /s]
θ_w	:		
	:		[s]

1

1.1

(free goods)

가

80

40%가

, , , , ,

. 800 2

40%가

가

. 가 가 ,

, - 가

. 20

21

가 가 .

60

가

(UN)

(1990)

8

가 (1

1,500

)

(Table 1.1).

가 가 가

(1),(2)

14 km³

97%가

(3)

70%

0.8%

(Table 1.2).

3

가

Table 1.1

	1994	2001	2006	2011
	322.1	342.9	345.4	346.5
	299.0	336.4	349.9	366.5
	+23.1	+6.5	- 4.5	- 20.0

:

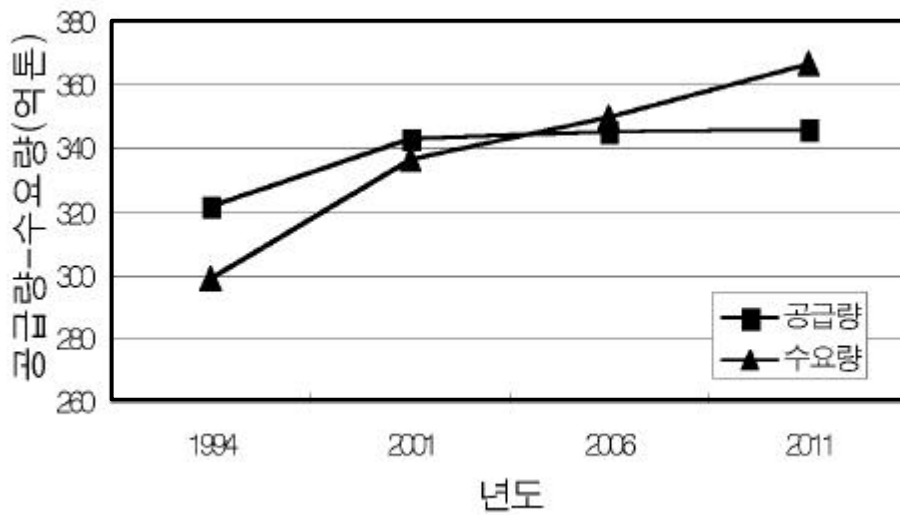
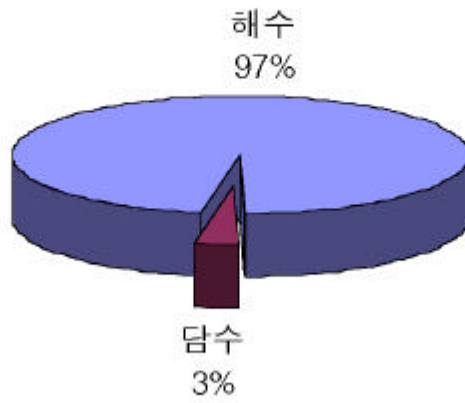
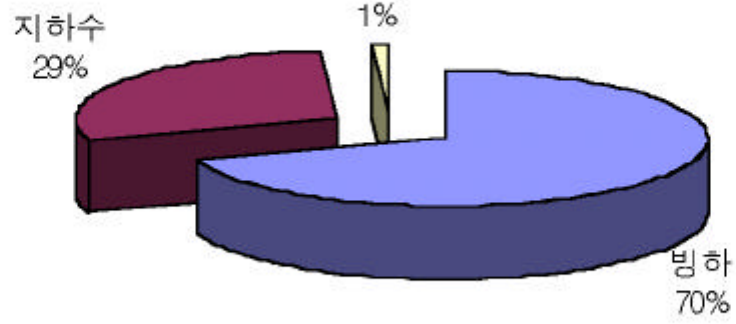

Table 1.2

수자원 량



담수의 구성



가

가

가

3%

97%

(Table 1.3).

가

1kg 540kcal)

(

가

Table 1.3

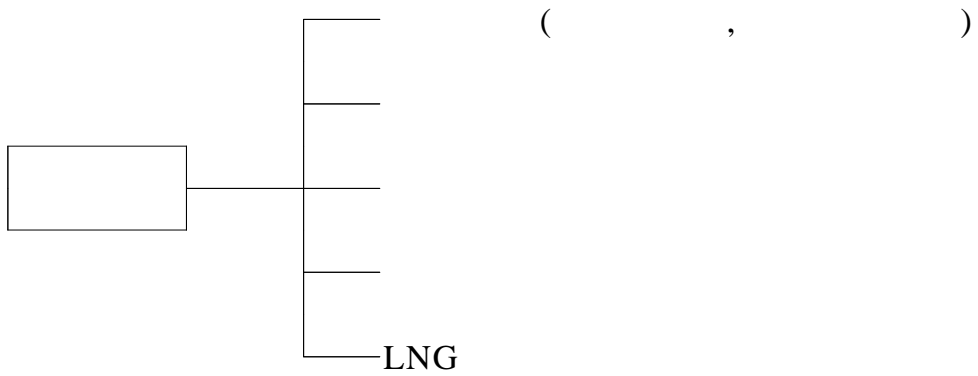
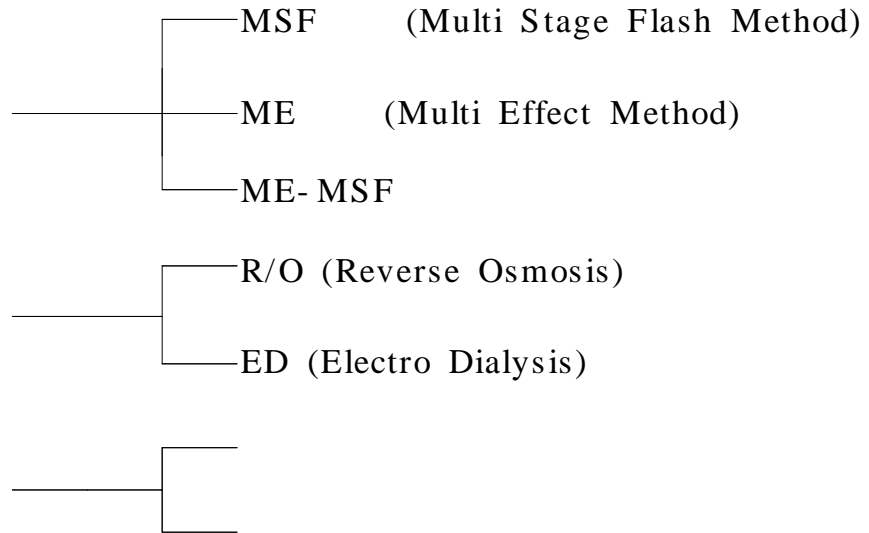

가

가

80kcal

1/7

가

가

LNG(Liquified Natural Gas :

가) 가 가 . 1987

LNG 1997 1000

가 (Table 1.4).

LNG - 162

가 가 . LNG

Table 1.4 LNG

	1999	2000	2003	2005	2010
LNG	12,617	13,702	16,777	17,260	20,814
LNG	13,142	14,596	16,980	16,980	14,680
	+525	+894	+203	- 280	- 6,134

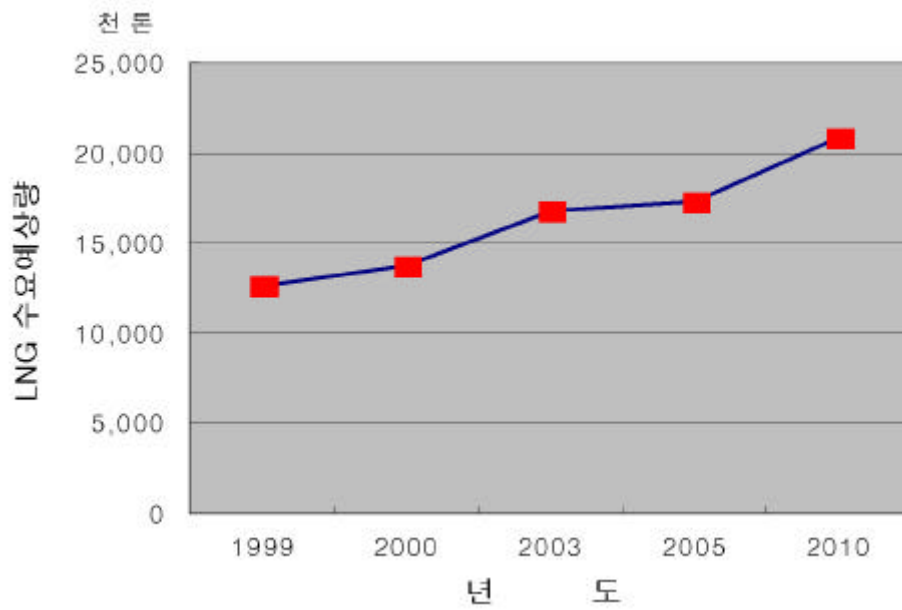

LNG가

, , , ,
가 , .

,
LNG
LNG

가
가 LNG 가 .

1.2

1.2.1

(Dendritic Ice)

가
가
가
,
(4) (8).

1.2.1.1

가
(0wt%)
Gilpin(4) (6)
가
(Dendritic Ice)
,
, Cheng(7) Fukusako(8)
Gilpin 가 가

, ,
 . Kashiwagi(9)
 ,
 가
 가
 . Saito(10)

Fig. 1.1 가

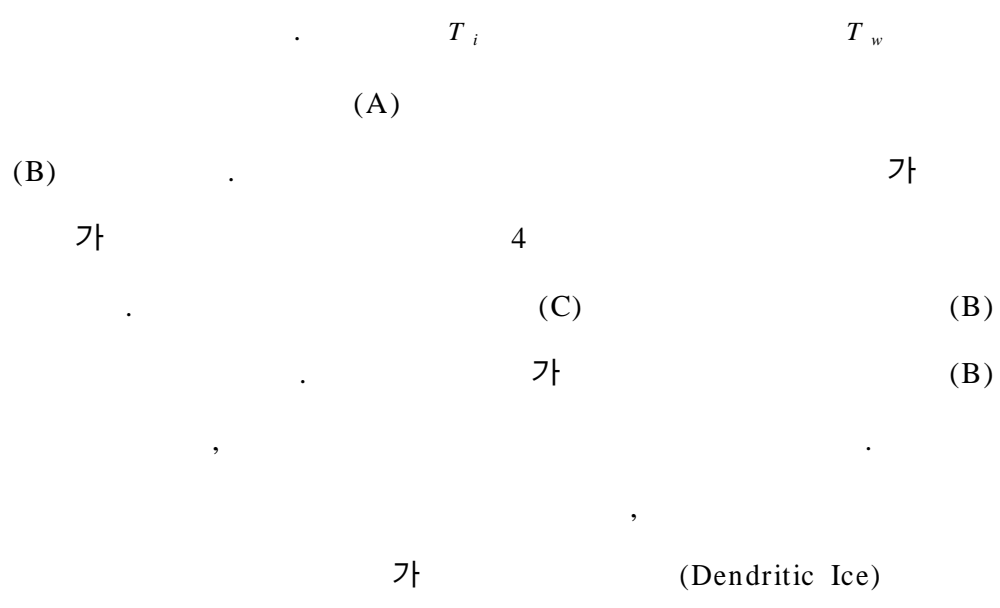

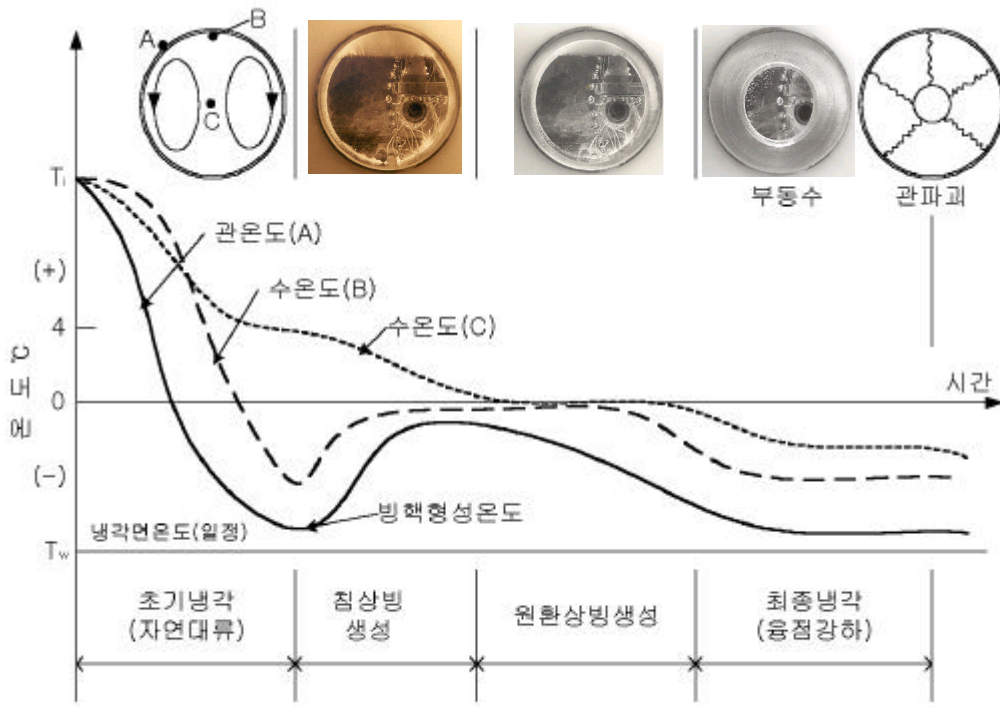

Fig. 1.1 Fresh water freezing behavior in a circular tube

0 . ,
(Annular Ice) .

1.2.1.2

가
(Constitutional Supercooling)

. ,
(前方) () 가
가 ,
가

Fig. 1.2

(II).

A , 가 .
가

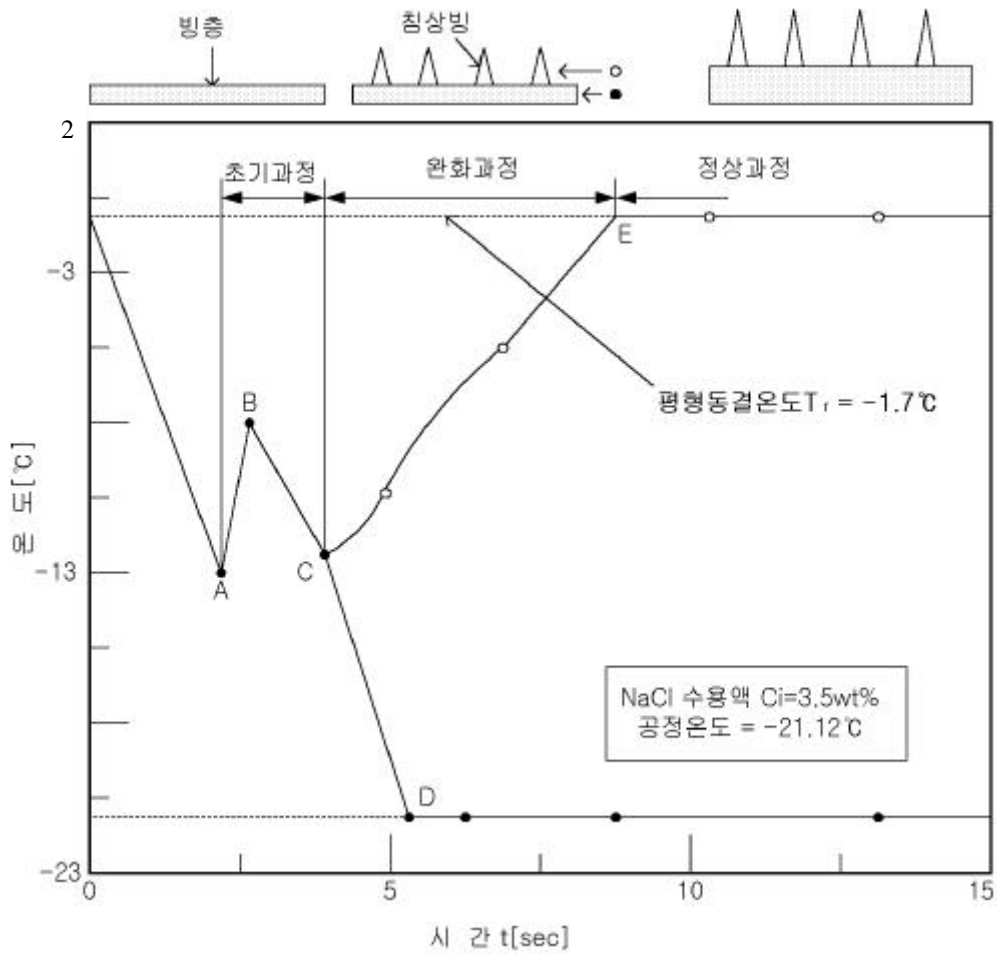

Fig. 1.2 Mechanism of supercooling phenomenon on salt water

(B).

C

.
가 가
(T_f) . 가
가
. . .

1.2.2

Terwilliger(12)

,

.

,

.

(13) (17)

1.3

가

LNG

LNG

2 ()

(18),(19)

가

(20) (23)

2

2.1

Fig. 2.1 . ,
,
() ,
가
가
(Test Section) 가 290mm, 180mm, 290mm
15mm 가
가 (銅) (148mm,
160mm, 3.5mm) .
• 15mm
가
•
735cm² 2450cm² .

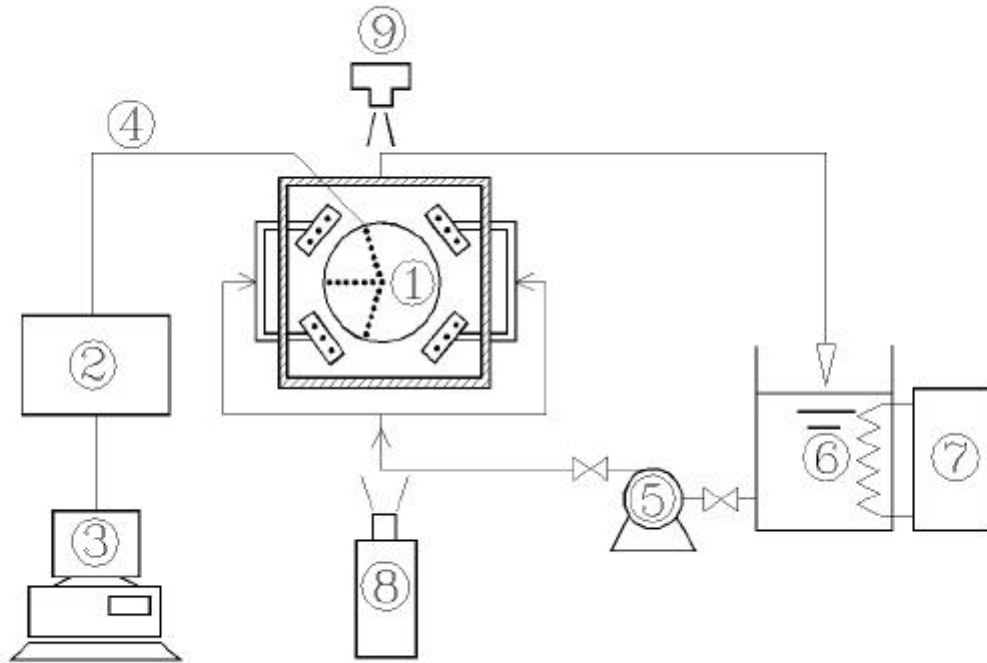

Test Section
Data Acquisition System
Personal Computer
Thermocouples
Brine Pump

Brine Tank
Refrigerating Machine
Ar Gas Laser
Camera

Fig. 2.1 Schematic diagram of experimental apparatus

(Refrigerating Machine) (40%

) (Brine Pump)

(Brine Tank)

C- A Type

90 °

3

Type

19 15q, 90q, 165o

가

(Data Acquisition System)

Personal Computer

(Method of Shadow Picturing)

Ar Gas Laser(ARGON 3.5W)

가 Tracing Paper

가

가

14mm,

1000mm

1mm

가

Fig. 2.2 (Test Section)

(Thermocouples)

(Freezing Rate)

Fig. 2.3

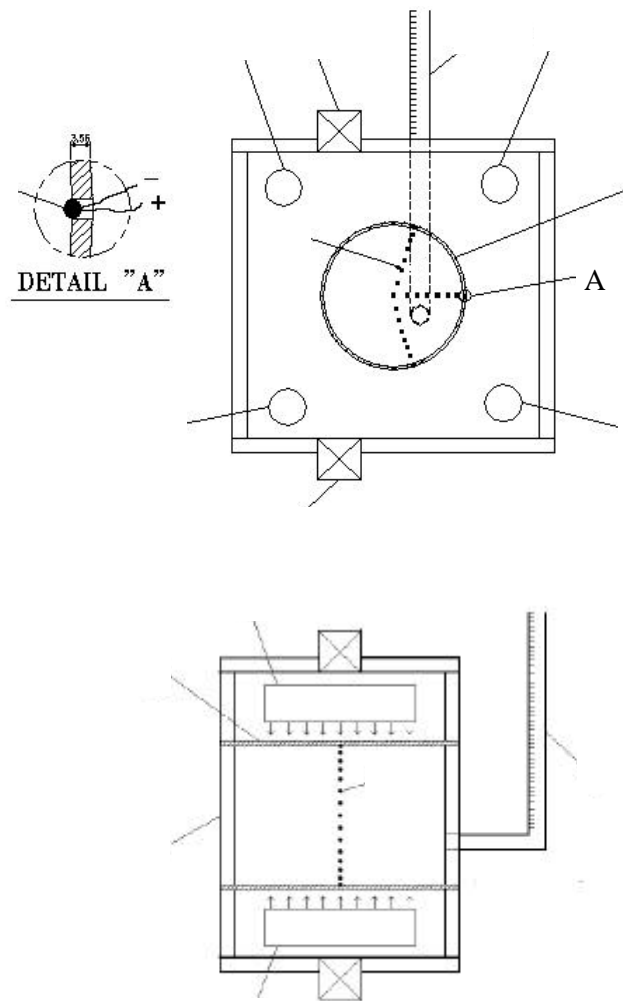

Copper Tube
Brine Nozzle
Pair Glass
Brine Inlet

Thermocouples
Brine Outlet
Expansion Tube

Fig. 2.2 Diagram of test section apparatus



Fig. 2.3 Photo of experimental apparatus

2.2

· , ,
Na, Mg, Ca, K, Cl, SO₄, CO₃, Br
H₃BO₃, F 가 10가
Na, Mg, Ca, K, Cl, SO₄ 6

Table 2.1

(24). Table 2.1

(NaCl)

, 가 3.5wt%
0.0wt%, 1.8wt%, 3.5wt%

(: ATAGO S-10E)

Fig 2.4

(25)

- 21.1

Table 2.1 Constituent parts on concentration of sea water
(g/kg- s.w.)

Cl	18.9799	Na	10.5561	CaSO ₄	1.3786
SO ₄	2.6486	Mg	1.2720	MgSO ₄	2.1025
HCO ₃	0.1397	Ca	0.4001	MgBr ₂	0.0775
Br	0.0646	K	0.3800	MgCl ₂	3.2813
F	0.0013	Sr	0.0133	KCl	0.7242
H ₃ BO ₃	0.0260			NaCl	26.6912
21.8601		12.6215		34.2553	

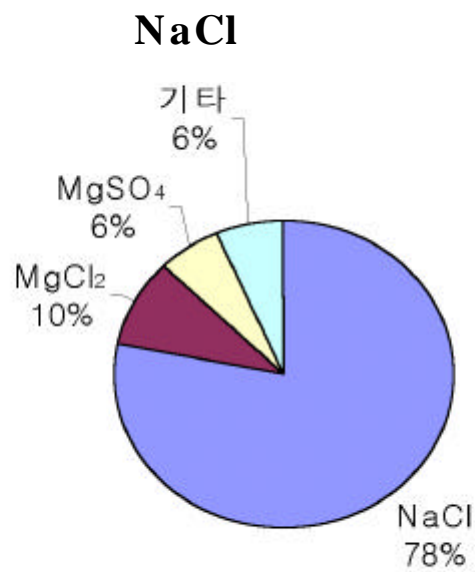

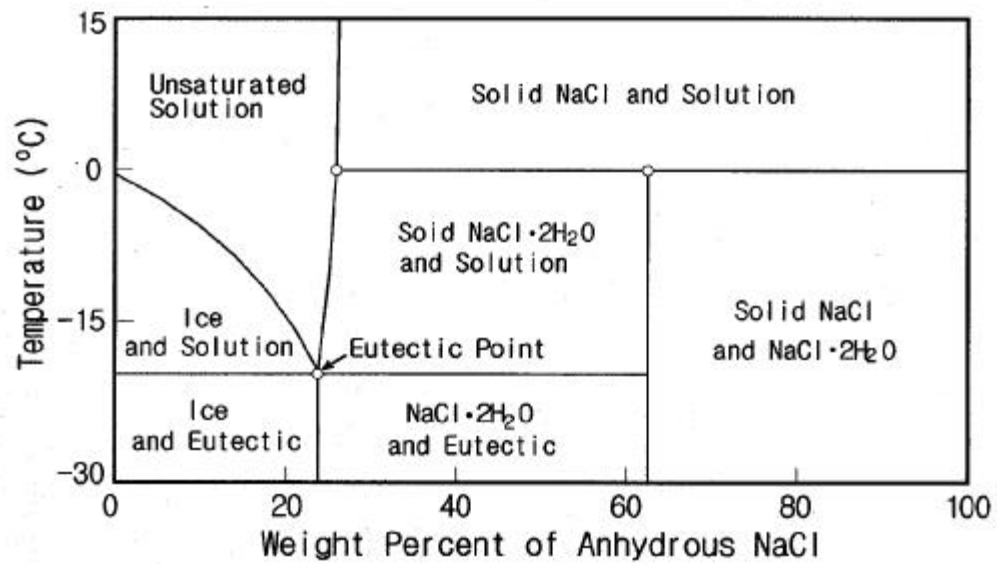

Fig. 2.4 Equilibrium phase diagram of aqueous solution

Parameter (Experimental conditions)

Table 2.2 (Experimental conditions)

가

,

5

가

가

가

가

10

Ar가

가 (Quantity of Freezing)

Rate) 가 (Freezing Rate)

, Fig 2.5

Table 2.2 An experimental conditions

Experiment	C_i (wt%)	T_w ()	T_f ()
1	0.0	- 15	0.0
2	1.8	- 15	- 0.7
3	3.5	- 15	- 1.7
4	0.0	- 10	0.0
5	1.8	- 10	- 0.7
6	3.5	- 10	- 1.7
7	0.0	- 5	0.0
8	1.8	- 5	- 0.7
9	3.5	- 5	- 1.7

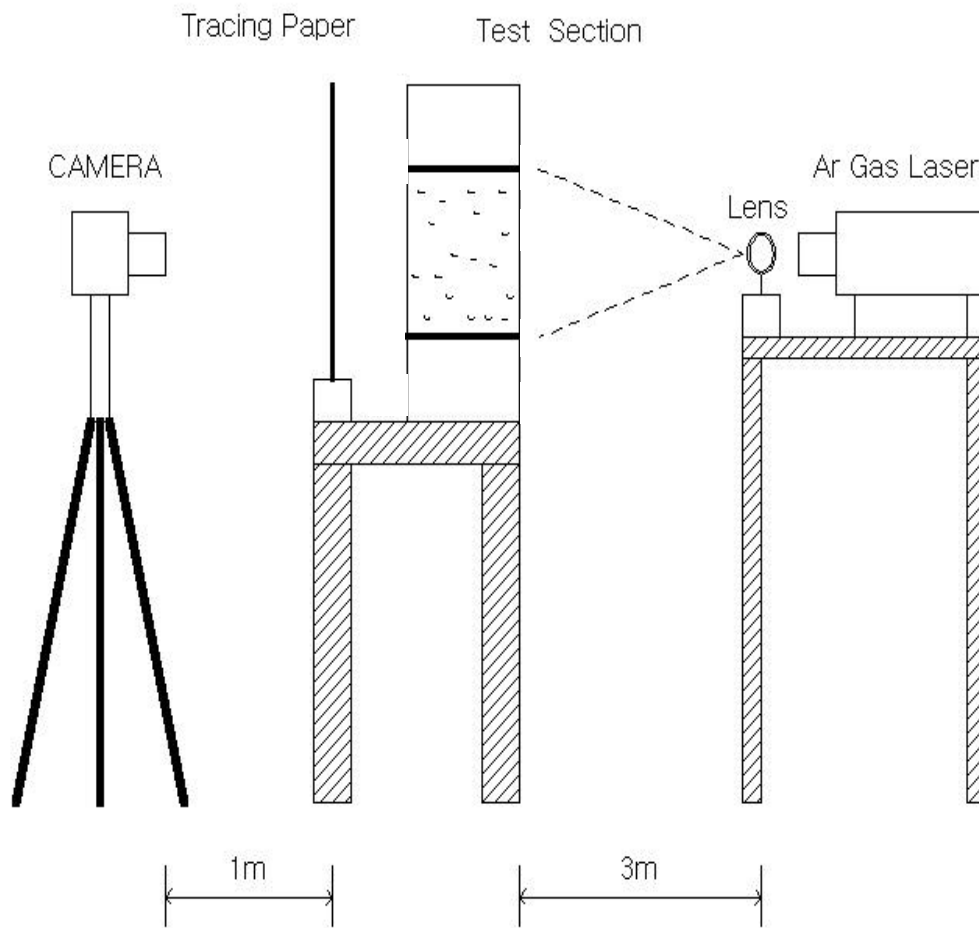

Fig. 2.5 Method of shadow picturing

3

3.1

(Liquid Ice)

(26),(27)

가 가

(20).

가

. Fig. 3.1

C=2.49%

가

C=2.49%

C가 2.49%

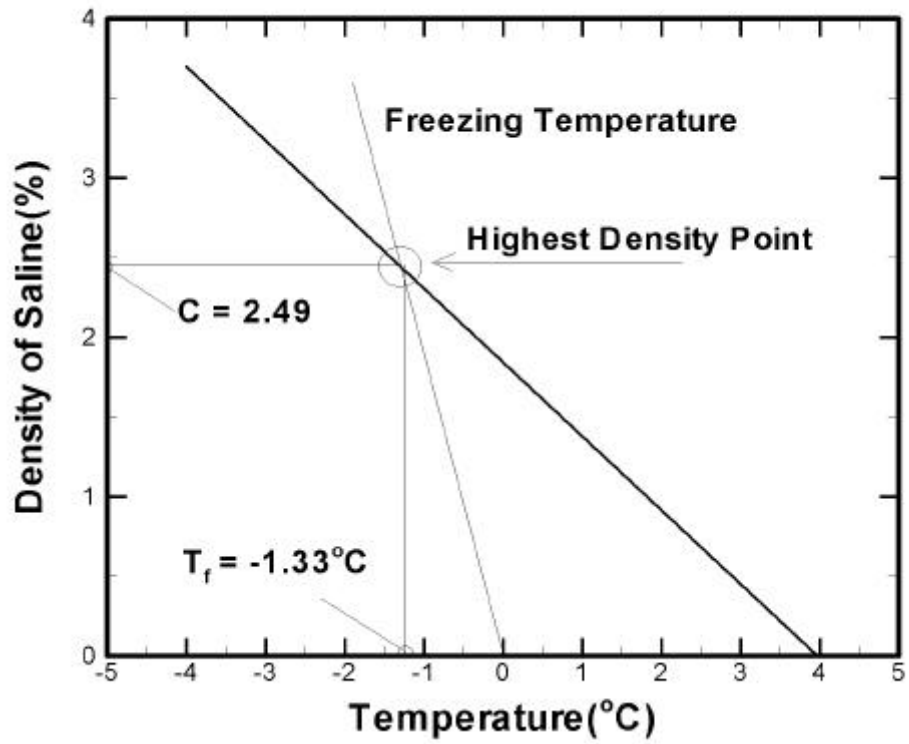

Fig 3.1 The relation of max. density temperature and freezing temperature of sea water

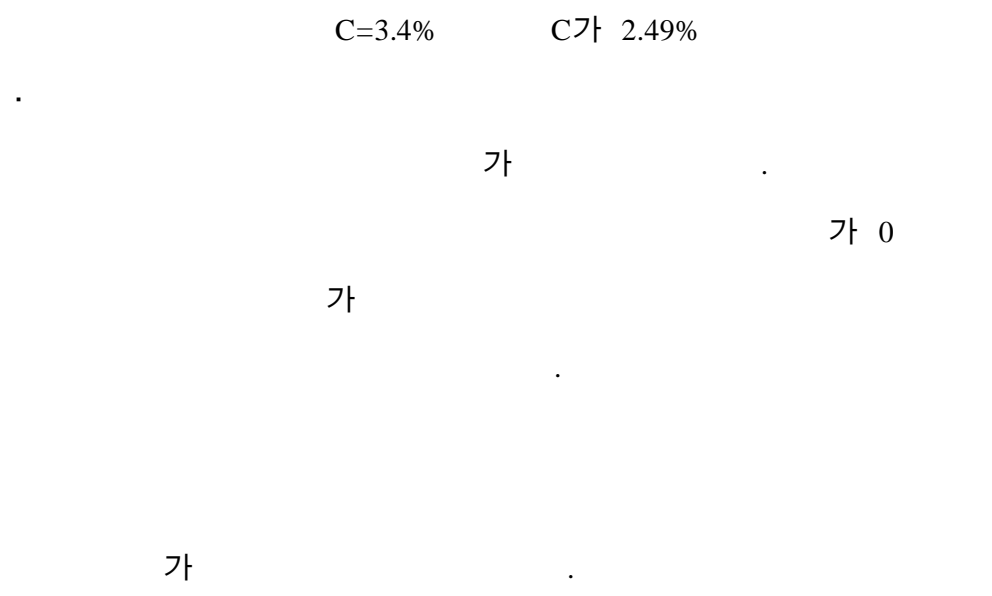
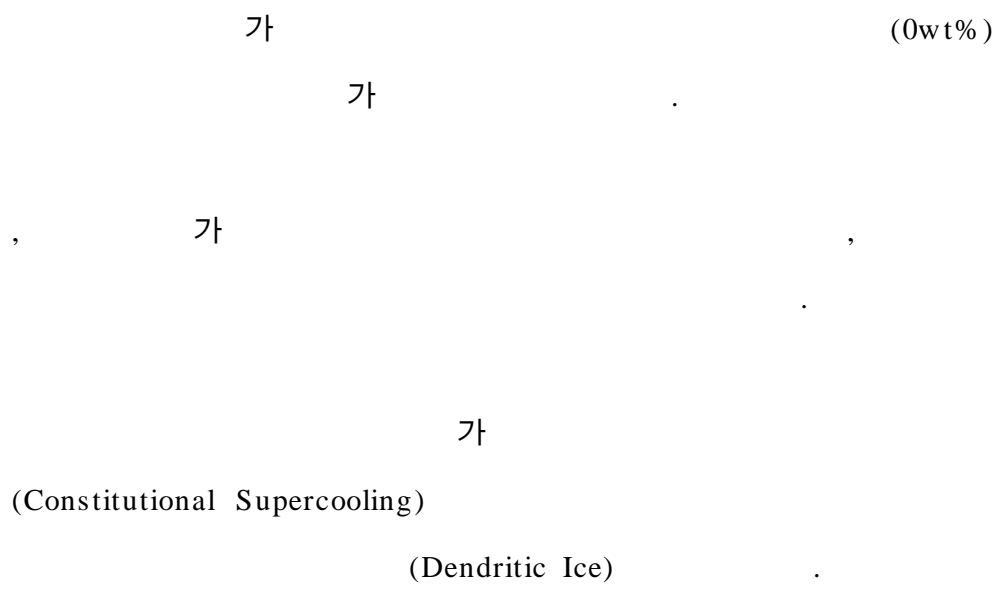
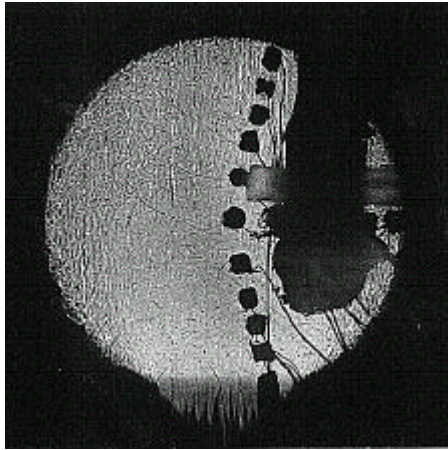
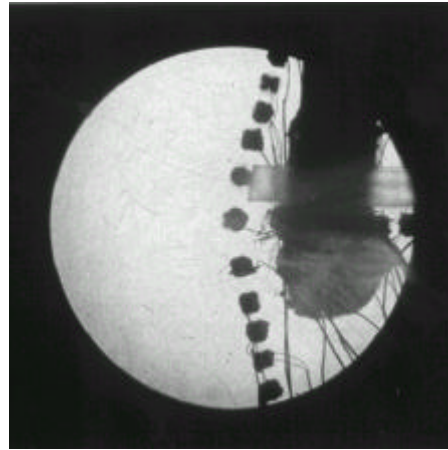

Fig. 3.2





(a) $C_i = 3.5\text{wt}\%$



(b) $C_i = 0.0\text{wt}\%$

Fig. 3.2 Effect of flow pattern on concentration of aqueous solution

가

가

가

Fig. 3.3

가 가

Fig. 3.4

가

가

가

Fig. 3.5

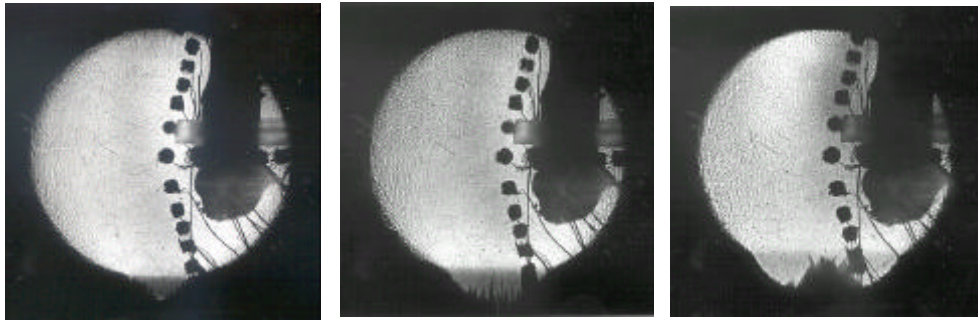

(a) Time = 10 min

(b) Time = 15 min

(c) Time = 25 min

**Fig. 3.3 Freezing characteristic of aqueous solution
; $C_i=3.5\text{wt}\%$**

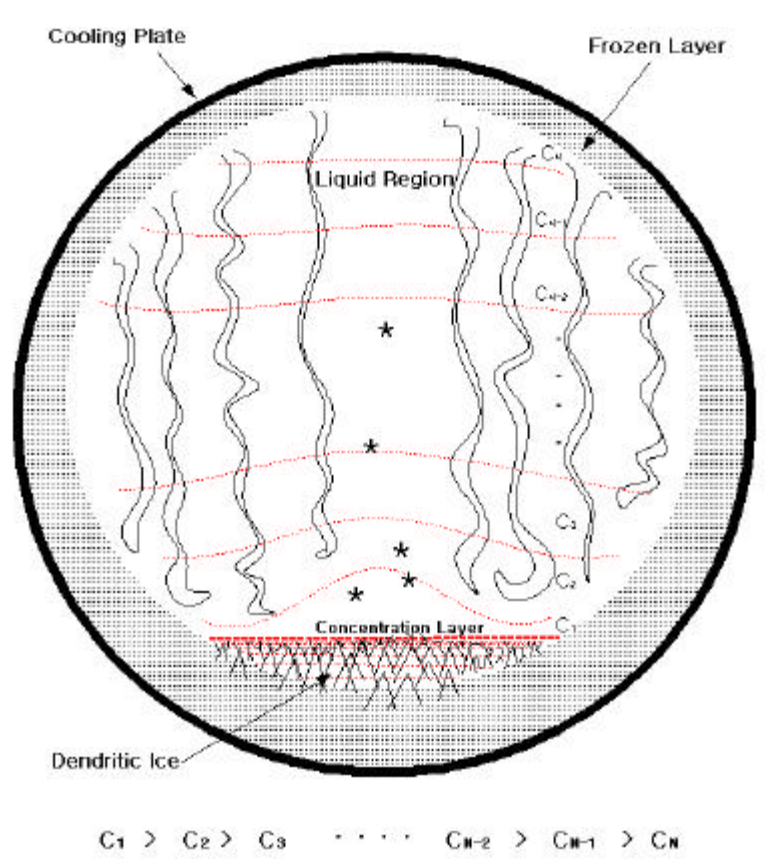
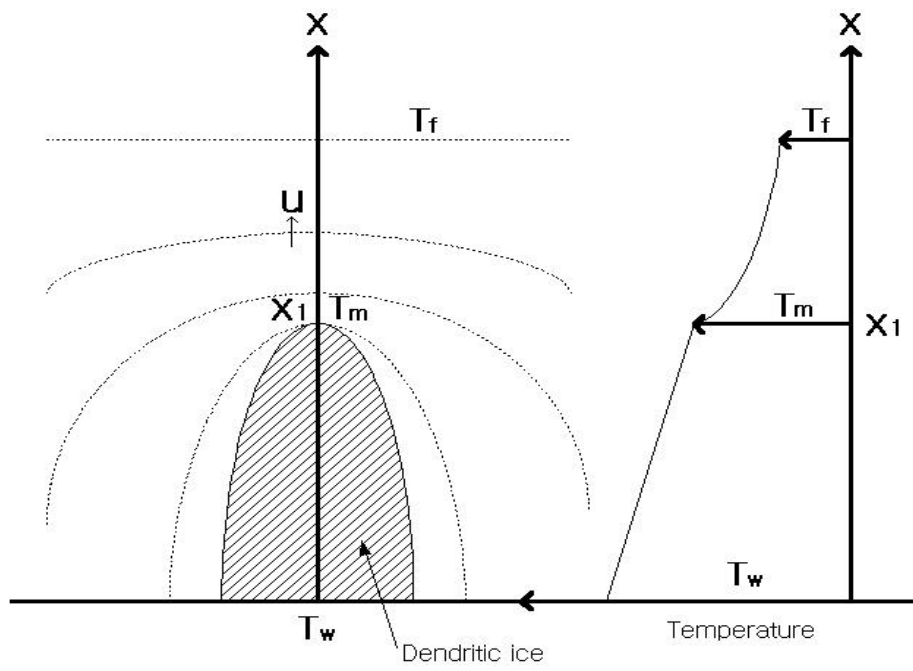

Fig. 3.4 Freezing mechanism of aqueous solution



$(T_f),$

(T_m)

(T_w)

가 .

가

Fig. 3.7 Fig. 3.8 Fig. 3.6

(Quantity of freezing)

(Freezing rate)

가

가

가

가

Fig. 3.8

가

가

가

가

Fig. 3.9 Fig. 3.11

$T_w = -10$, Fig. 3.12

Fig. 3.14

$T_w = -15$

가

Fig. 3.7, 3.10

3.13

가

가

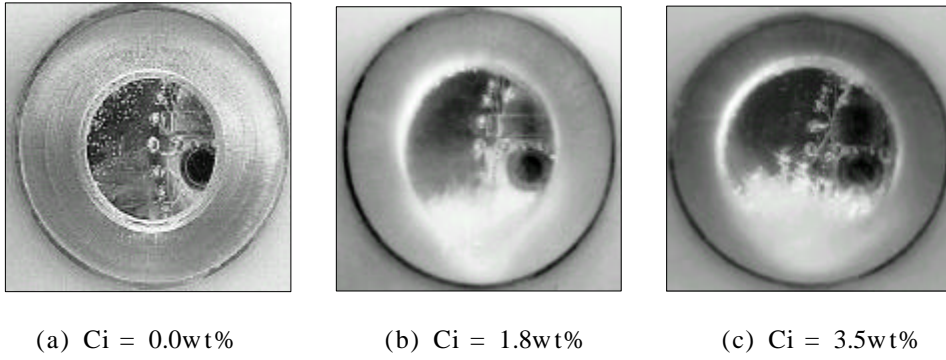

Fig. 3.6 Effect of concentration of aqueous solution on freezing behavior ; $T_w = -5$, Time = 4hr.

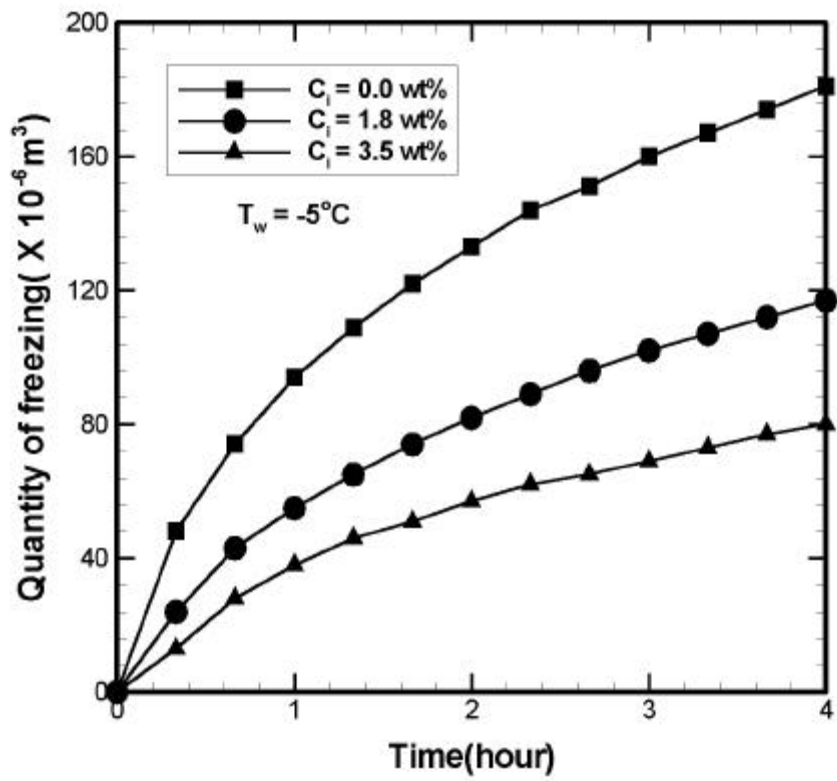

Fig. 3.7 Quantity of freezing

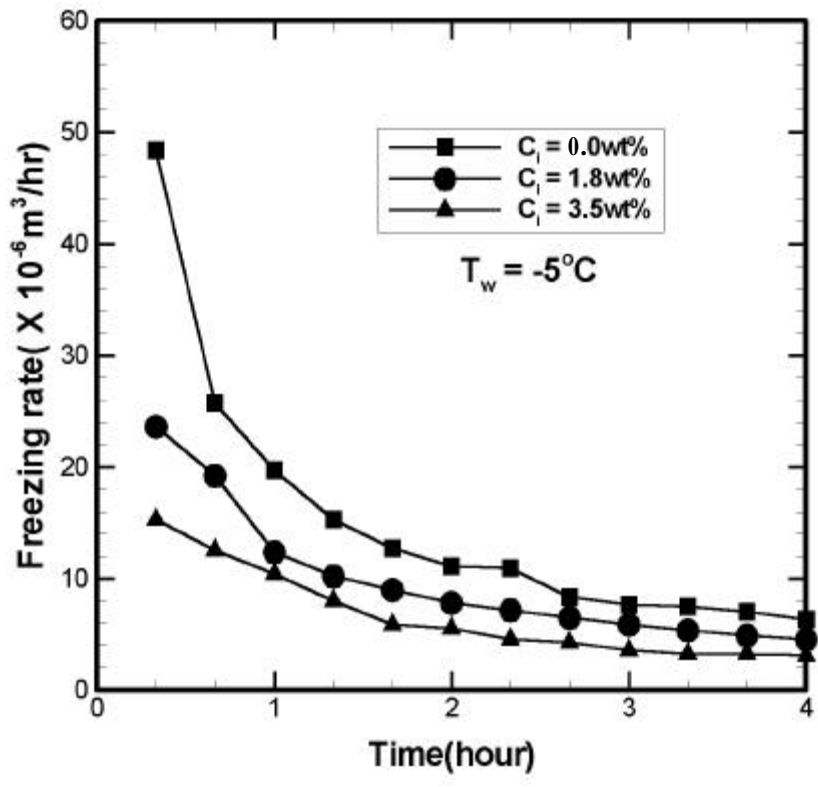

Fig. 3.8 Freezing rate



(a) $C_i = 0.0\text{wt}\%$

(b) $C_i = 1.8\text{wt}\%$

(c) $C_i = 3.5\text{wt}\%$

Fig. 3.9 Effect of concentration of aqueous solution on freezing behavior ; $T_w = -10$, Time = 3hr.

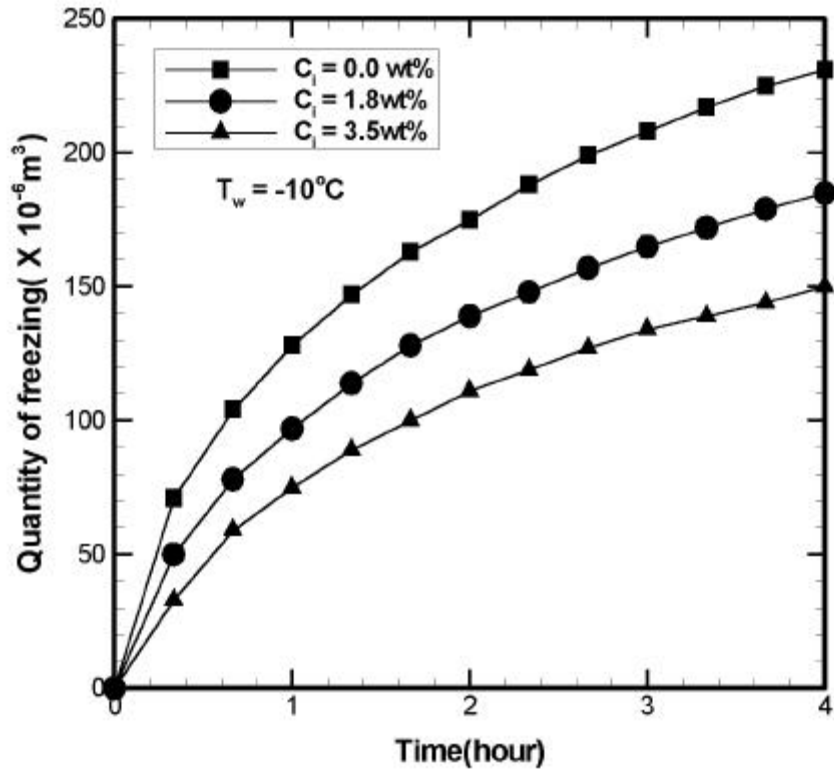

Fig. 3.10 Quantity of freezing

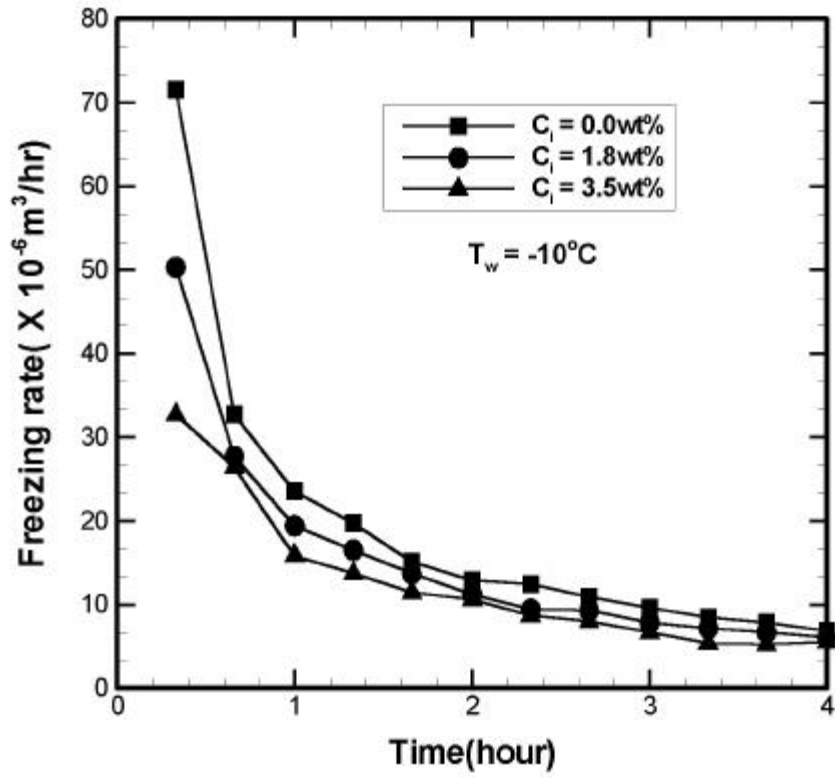

Fig. 3.11 Freezing rate

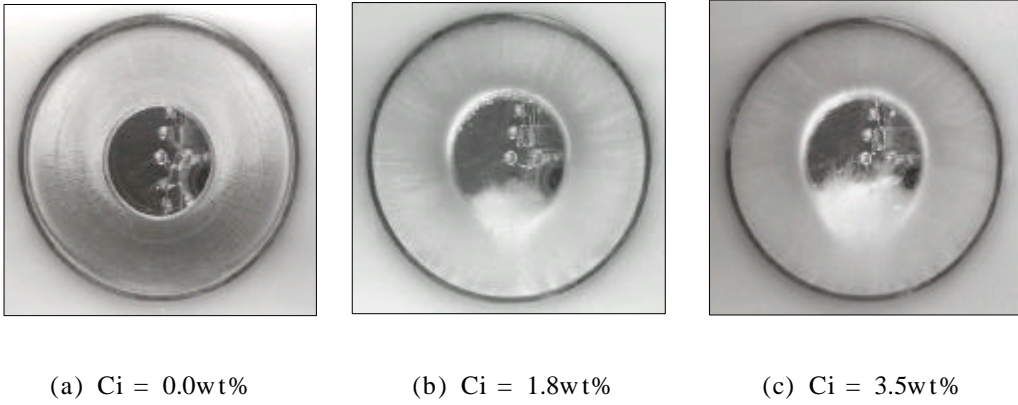

Fig. 3.12 Effect of concentration of aqueous solution on freezing behavior ; $T_w = -15$, Time = 2hr.

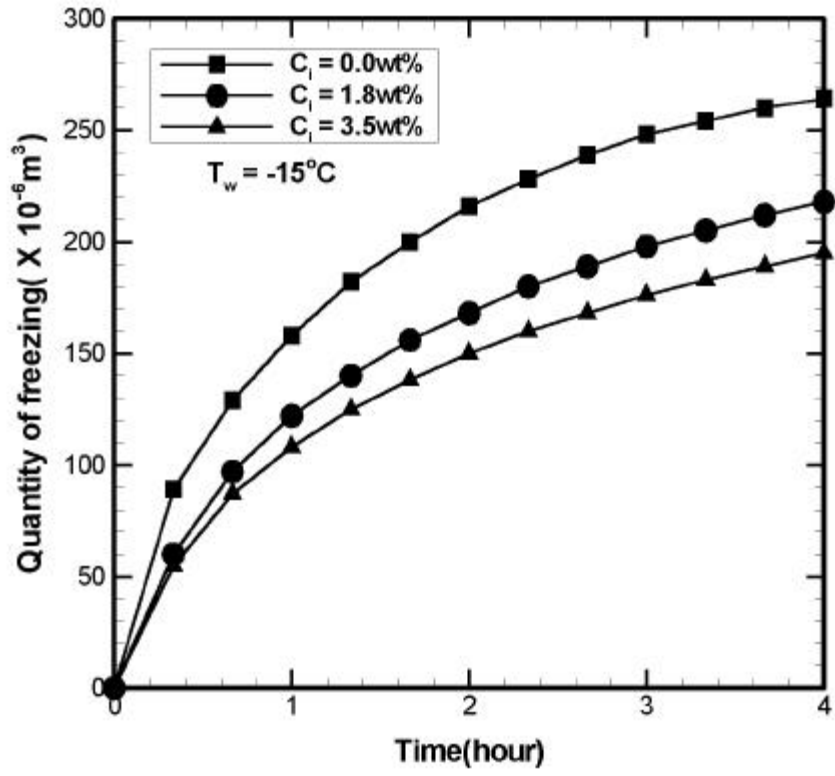

Fig. 3.13 Quantity of freezing

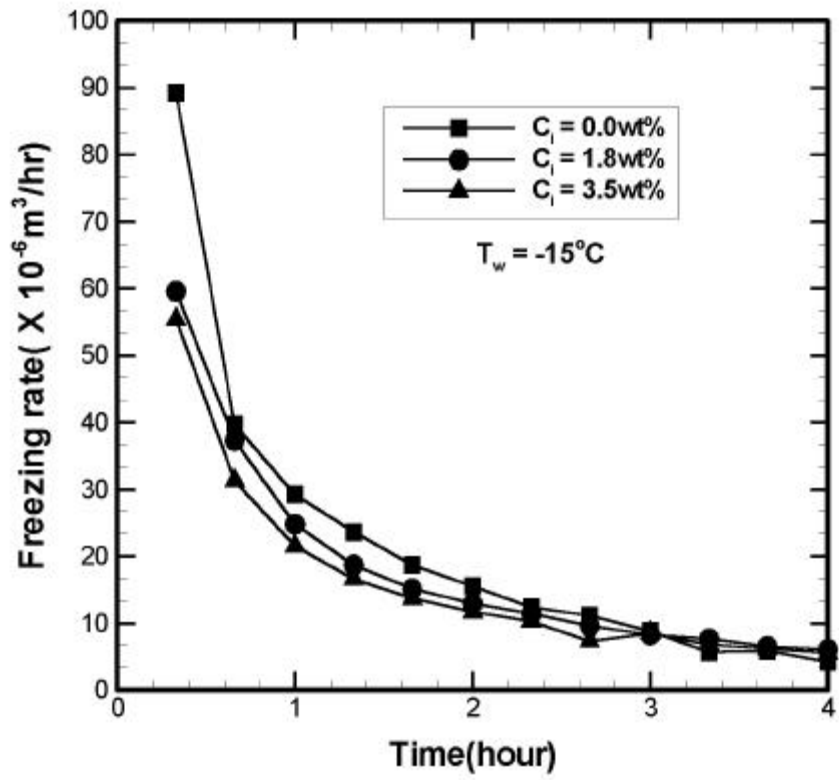
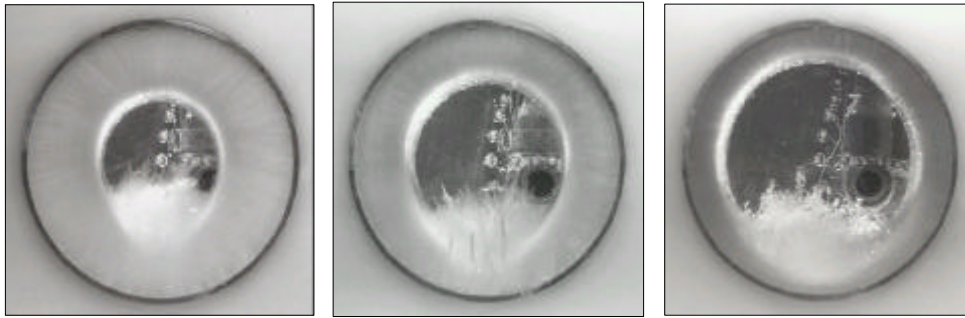

Fig. 3.14 Freezing rate

가 Fig. 3.18 Fig. 3.20 $C_i=1.8\text{wt}\%$, Fig. 3.21 Fig.
3.23 $C_i=0.0\text{wt}\%$ 가



(a) $T_w = -15$

(b) $T_w = -10$

(c) $T_w = -5$

Fig. 3.15 Effect of cooling wall temperature on freezing behavior ; $C_i = 3.5\text{wt}\%$, Time = 2hr.

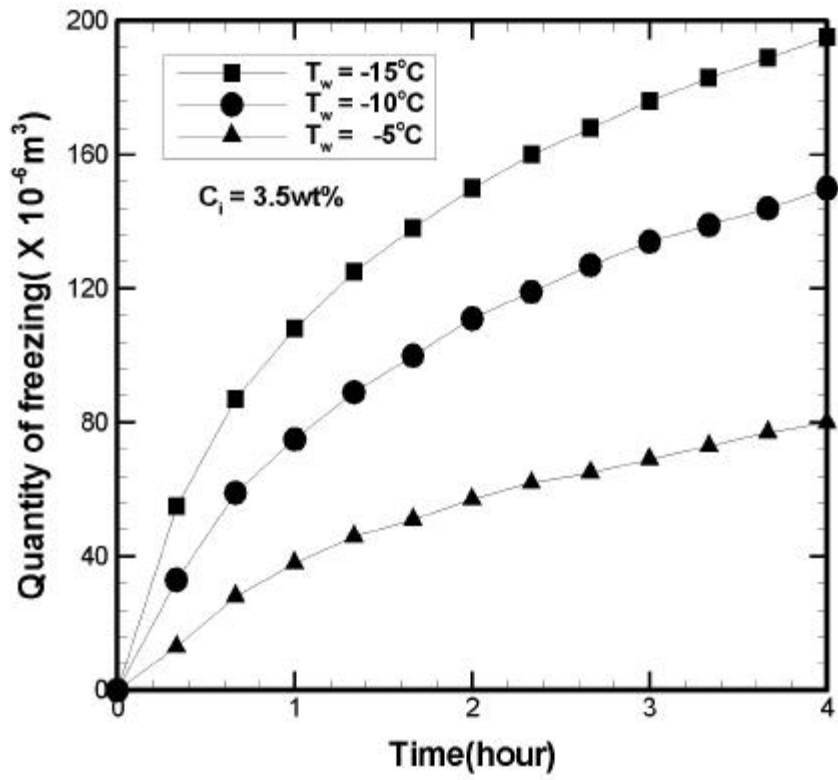

Fig. 3.16 Quantity of freezing

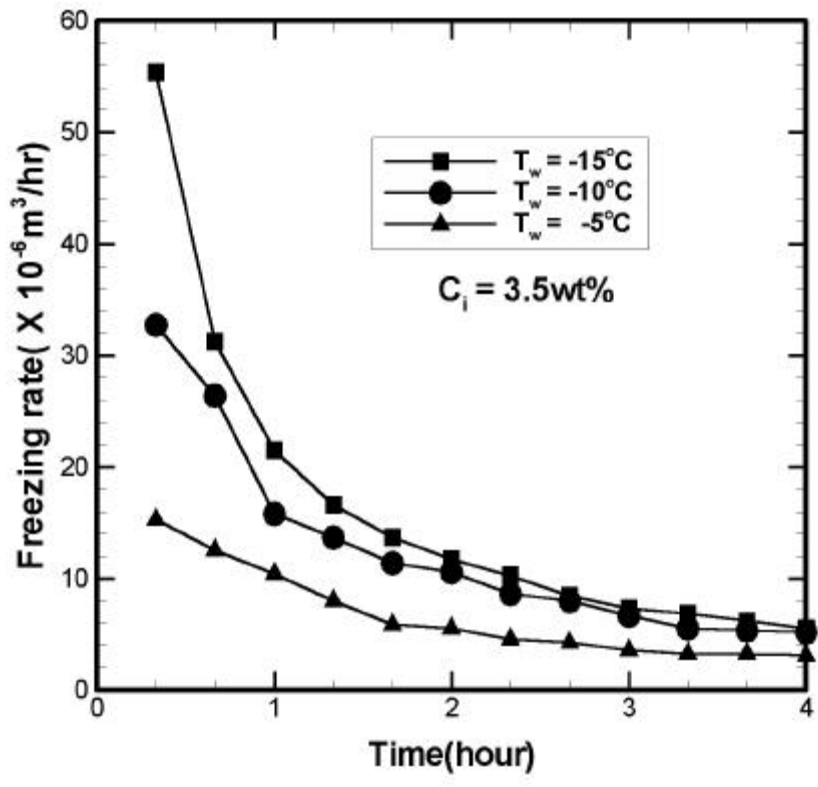
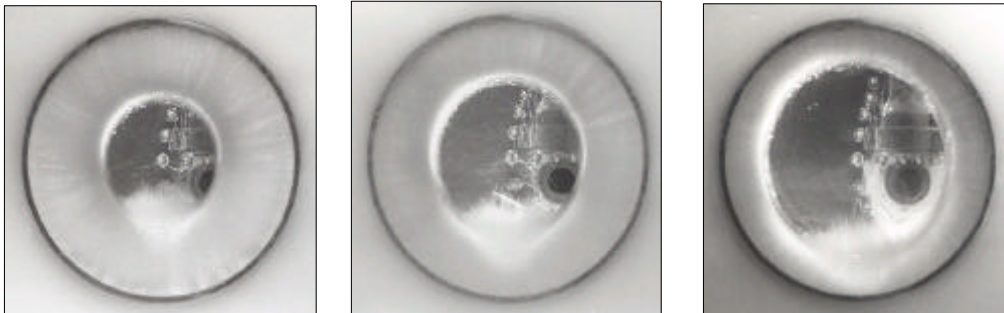

Fig. 3.17 Freezing rate



(a) $T_w = -15$

(b) $T_w = -10$

(c) $T_w = -5$

Fig. 3.18 Effect of cooling wall temperature on freezing behavior ; $C_i = 1.8\text{wt}\%$, Time = 2hr.

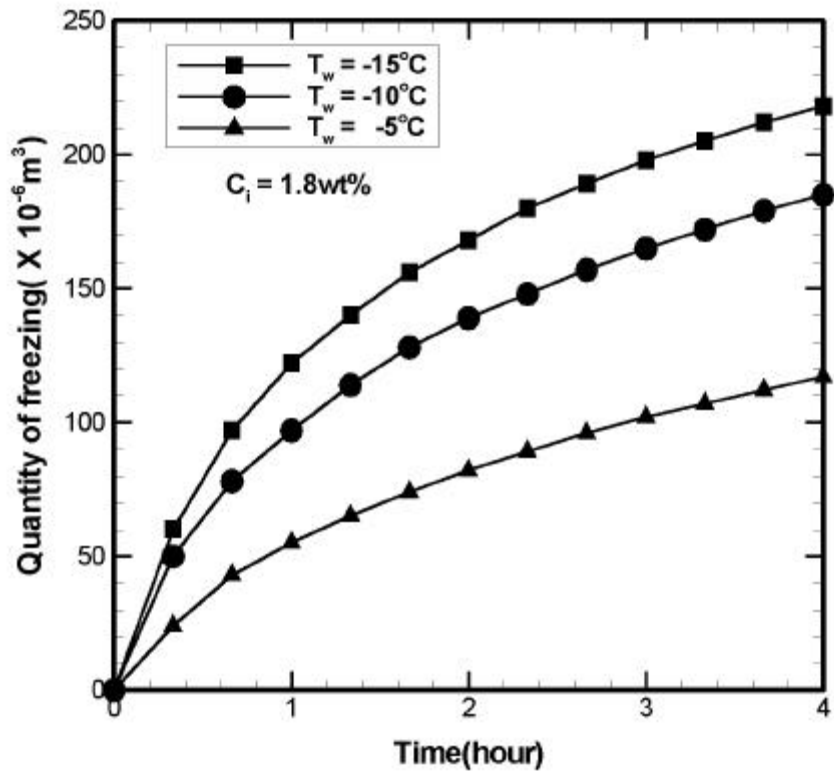

Fig. 3.19 Quantity of freezing

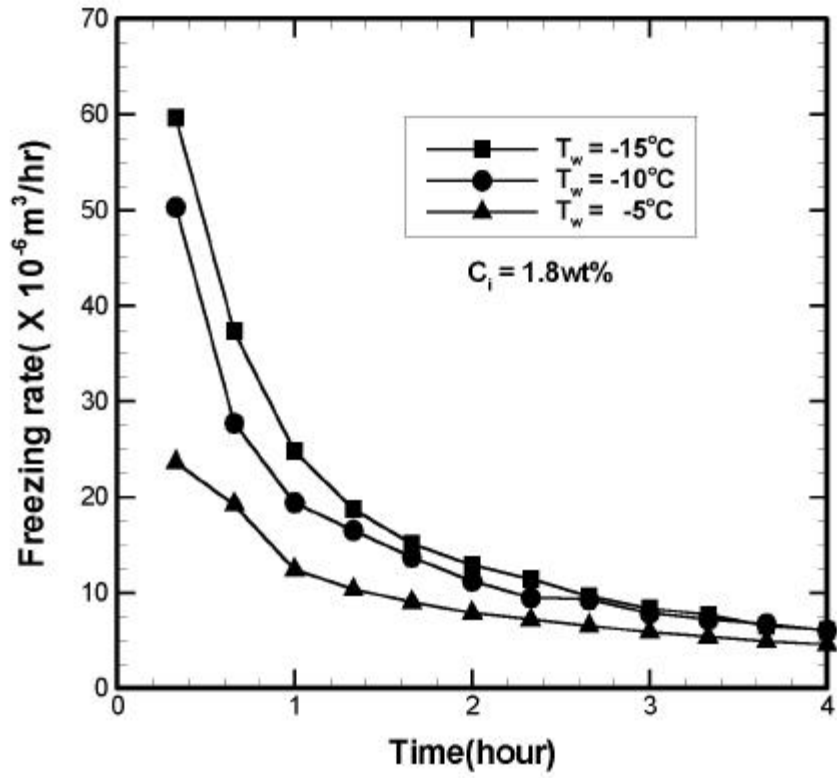
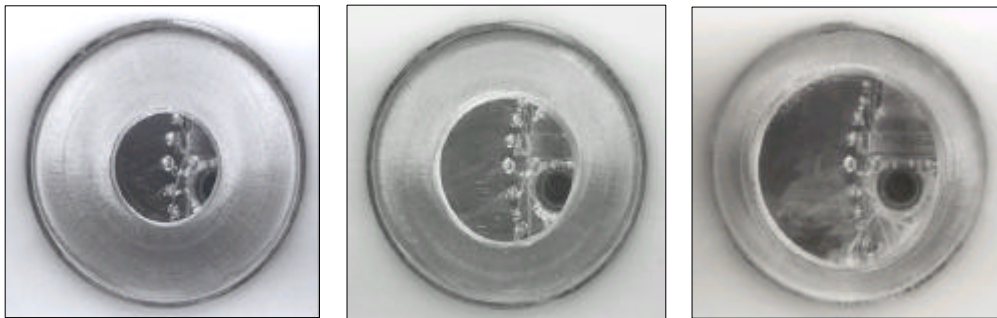

Fig. 3.20 Freezing rate



(a) $T_w = -15$

(b) $T_w = -10$

(c) $T_w = -5$

Fig. 3.21 Effect of cooling wall temperature on freezing behavior ; $C_i = 0.0\text{wt}\%$, Time = 2hr.

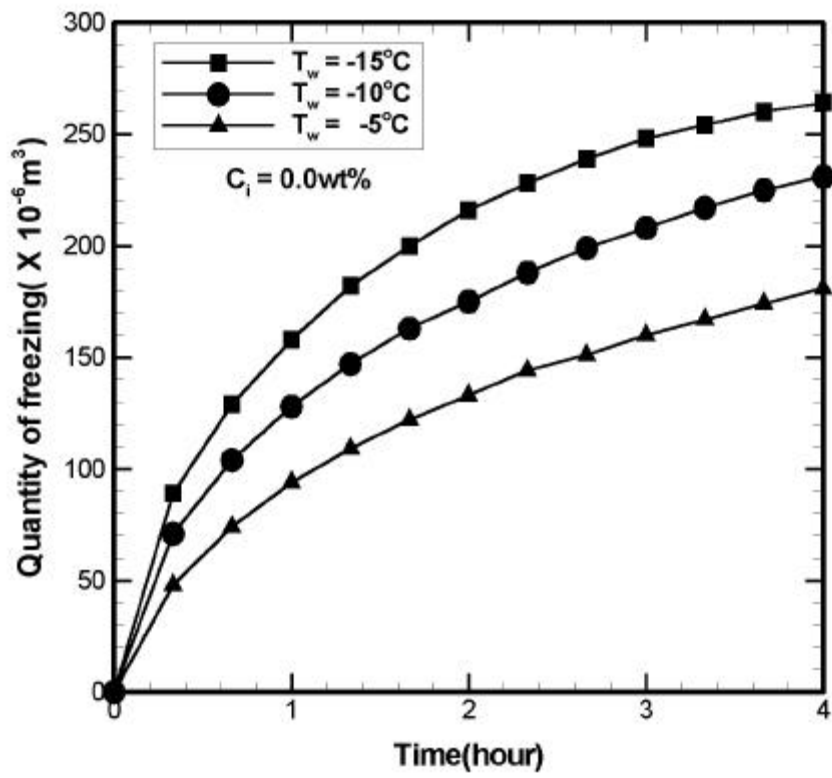

Fig. 3.22 Quantity of freezing

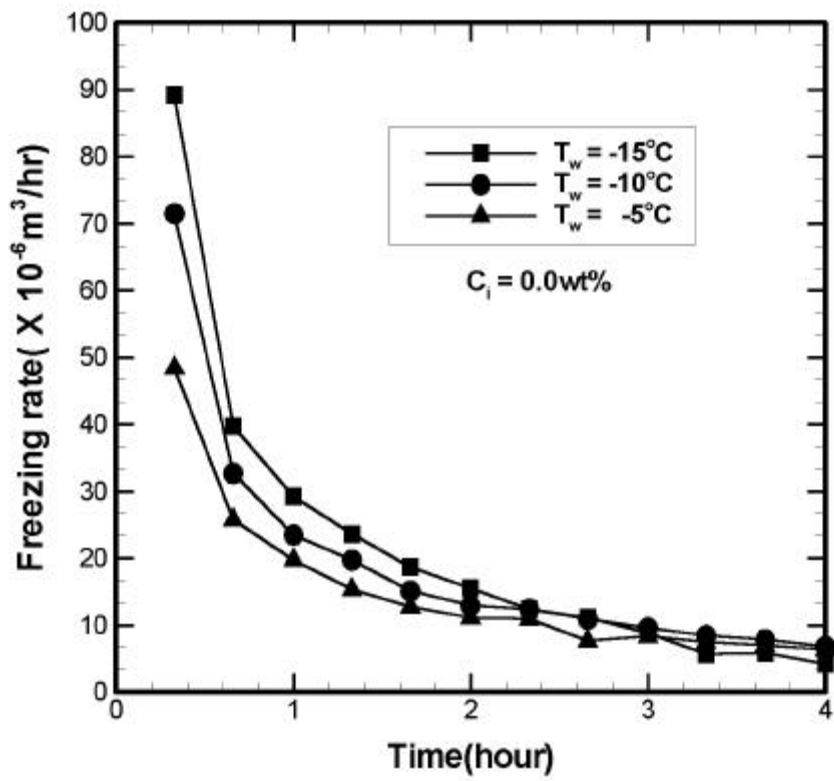

Fig. 3.23 Freezing rate

3.4

Fig. 3.24

$C_i=3.5\text{wt}\%$

, $C_i=0.0\text{wt}\%$

가

Fig. 3.25

Fig. 3.26

,

$T_w=-15$

가

가

(T_f)

가

(T_f)

, $0.0\text{wt}\%$

가

, $3.5\text{wt}\%$

가

가

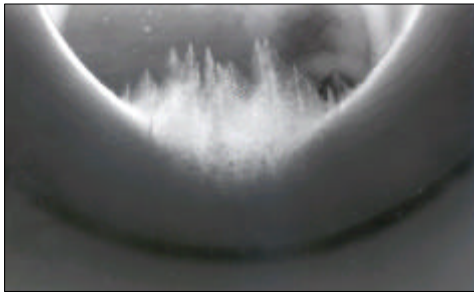

(a) $C_i = 3.5 \text{ wt}\%$



(b) $C_i = 0.0 \text{ wt}\%$

Fig. 3.24 Configuration of frozen layer

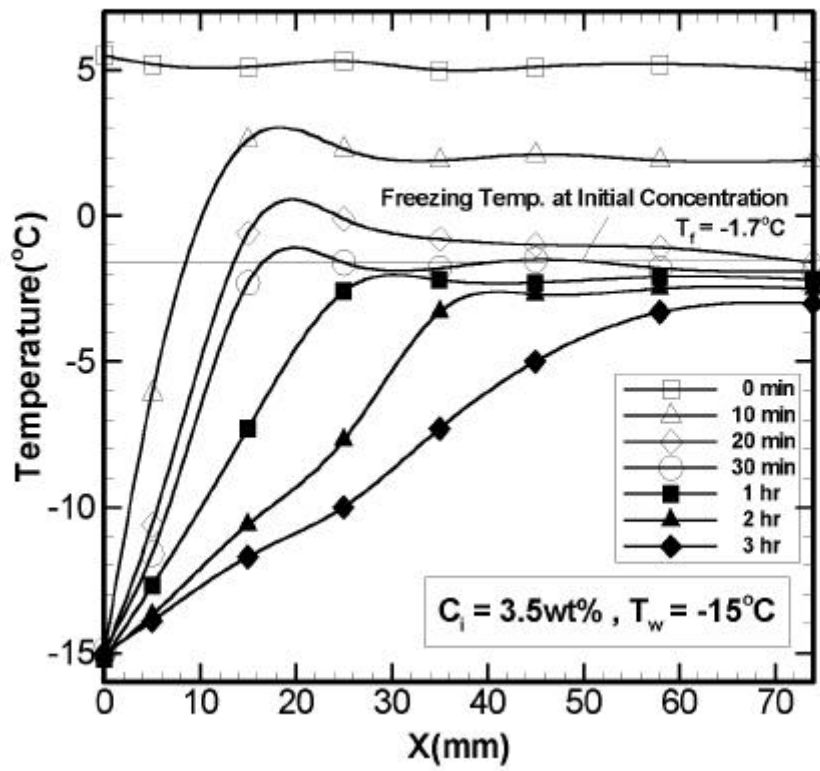

Fig. 3.25 Frozen layer and temperature distribution

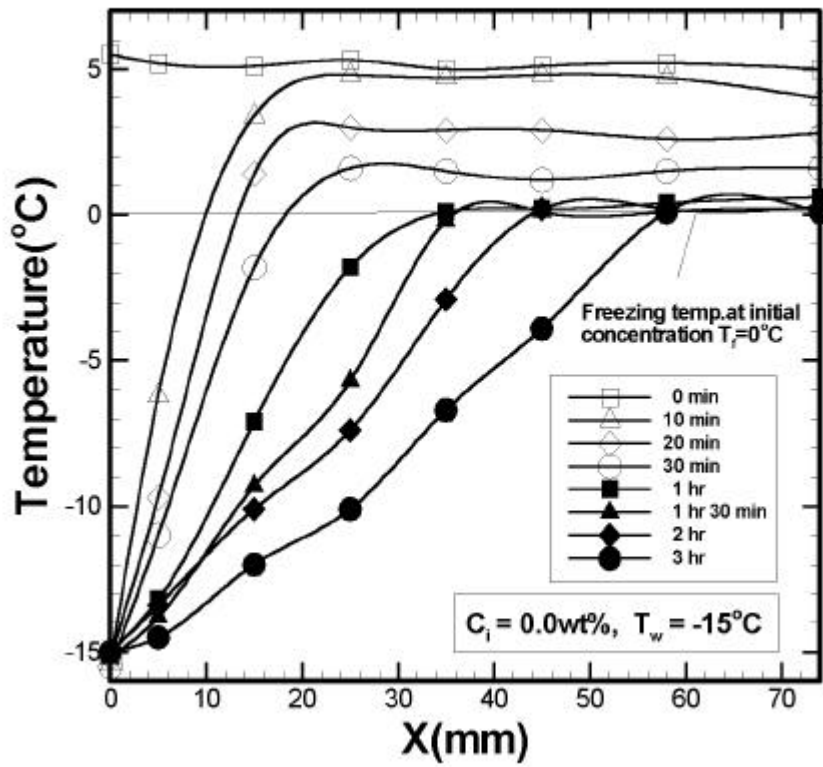

Fig. 3.26 Frozen layer and temperature distribution

가 . 가

가 .

가 가

Fig. 3.27 (3.5wt%) (0.0wt%) (165 °),
(90 °), (15 °)

가 , ,

가 .

4 가

가 .

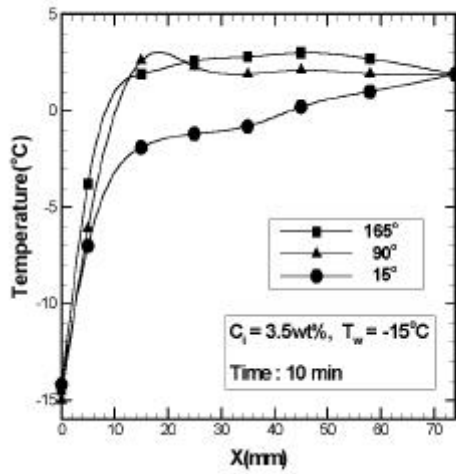

(a) $C_i = 3.5\text{wt}\%$

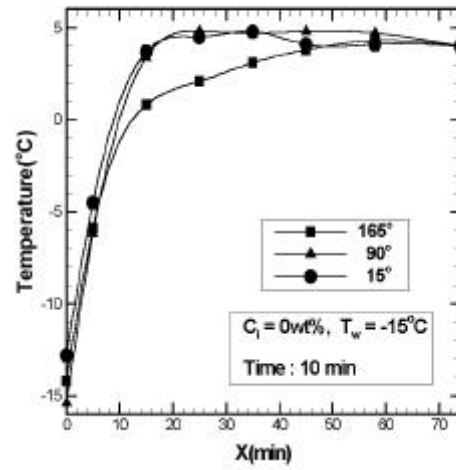

(b) $C_i = 0.0\text{wt}\%$

Fig. 3.27 Comparison of temperature distribution ; $T_w = -15$, $\text{Time} = 10\text{min}$.

3.5

R_f

$$R_f = f(\theta_w, F_0) \quad (3.1)$$

$$R_f (\quad) = \frac{V_f}{H_0}$$

$$\theta_w (\quad) = \frac{T_f - T_w}{T_0 - T_f}$$

$$F_0 \text{ (Fourie)} = \frac{\alpha \cdot \tau}{H_0^2}$$

$\theta_w \quad F_0$

R_f

Fig. 3.28

$\pm 15\%$

$$R_f = 4.52 \times 10^{-3} \cdot \theta_w^{0.75} \cdot F_0^{0.52} \quad (3.2)$$

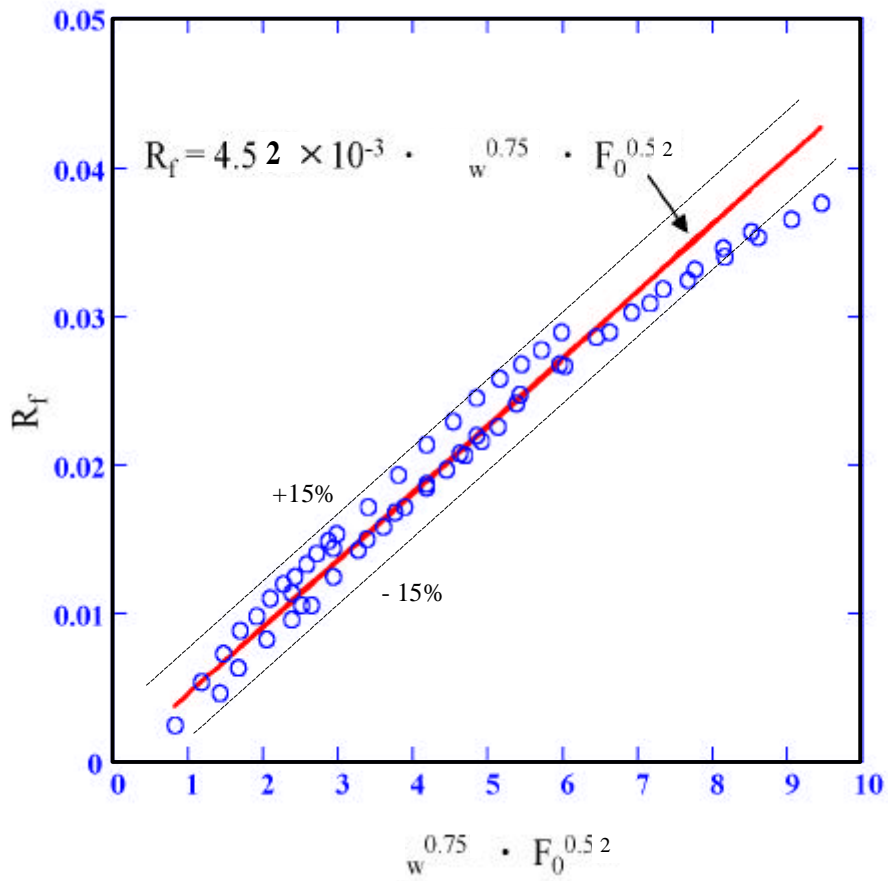

Fig. 3.28 Nondimensional freezing rate

4

LNG

, ,
가

(1) . 가 ,
가 가 .

(2) ,

(3) ,
가

(4) .

$$R_f = 4.52 \times 10^{-3} \cdot w_{0.75} \cdot F_{0.052}$$

가

가

가

가

(28).

()

(Liquid Ice)

(29)

(Liquid Ice)

LNG

가 LNG 1 (Liquid Ice)

가 가 . ,

- (1) , , , "LNG " ,
 , 18 , 5 , pp. 1 11, 1994
- (2) , , " " ,
 , pp. 105 109, 1996
- (3) David, J.Kukulka, Benjamin, Gebhart, and Joseph, C.Mollendorf,
"Thermodynamic and Transport Properties of Pure and Saline
Water", Advances in Heat Transfer, Vol 18, Academic Press, Inc.,
1987
- (4) Gilpin, R.R., "The Effect of Cooling Rate on the Formation of
Dendritic Ice in a Pipe With No Main Flow", Trans. ASME. J. Heat
Transfer, 99, pp. 419 424, 1977
- (5) Gilpin, R.R., "The Effects of Dendritic Ice Formation in Water
Pipe", Int. J. Heat Mass Transfer, 20, pp. 693 699, 1977
- (6) Gilpin, R.R., "Cooling of a Horizontal Cylinder of Water Through
its Maximum Density Point at 4 " , Int. J. Heat Mass Transfer, 18,
pp. 1307 1315, 1975
- (7) Cheng, K.C., Takeuchi, M., "Transient Natural Convection of
Water in a Horizontal Pipe with Constant Cooling Rate Thought 4 "

J. Heat Transfer, 98, pp. 581-587, 1976

(8) 福迫尙一郎ら, "成層をなす圓管内流體の自然對流熱傳達", 日本機械學會論文集, 54, 499, pp. 641, 1989

(9) 柏木孝夫ら, "過冷却域を有する水の凍結開始に及ぼす自然對流の影響", 日本機械學會論文集, 53, 490, pp.1822-1827, 1988

(10) 齋 ら, "過冷却をとこなう凝固科程の研究", 日本機械學會論文集, 54, 502, pp. 1439-1446, 1989

(11) 福迫尙一郎ら, "低溫環境下の傳熱現想とその應用", 養賢堂發行, pp. 156-157, 1996

(12) Terwilliger, P. and Dizio, S.F., "Salt rejection phenomena in the freezing of saline solutions in cells", Chemical Engineering Science 25, pp. 1331-1349, 1970

(13) Stephan, K., Genthner, K., and Holzknrecht, B., "Heat Conduction in Solidification Coupled with Phase Transformation in the Solid", Proc. of the 5th. Int. Heat Transfer Conf. Vol. 1, pp. 235-239, 1974

(14) Hayashi, Y., and Komori, T., "Investigation of Freezing of Salt Solution in Cells", J. Heat Transfer, Vol.101, pp. 459-464, 1979

(15) Hayashi, Y., Kunimine, K. and Ngamoto, T., "Study on Freezing of Undercooled Solution", Proc. of 1989 Int. Symposium on Cold Regions Heat Transfer, pp. 85-90, 1989

(16) Fang, L. J., Cheung, F. B., Linehan, J. H., and Pedersen, D. R.,

- "Selective Freezing of a Dilute Salt Solution on a Cold Ice Surface",
 J. Heat Transfer, Vol.106, pp. 385- 393, 1984
- (17) Chellaiah, S. and Viskanta, R., "Freezing of Salt Solution on a
 Vertical Wall", Exp. Heat Transfer 1, pp. 181 195, 1988
- (18) , , , "
 ", , 21 , 5 , pp. 564
 570, 1997
- (19) , , , "
 ", , , pp.
 23 29, 1998
- (20) Johnson.R.S and Mollendorf.J.C, "Transport From a Vertical Ice
 Surface Melting In Saline Water", Int.J.Heat Mass Transfer, Vol. 27,
 No. 10, pp. 1928 1932, 1982
- (21) Beckermann. C, "Melting and Solidification of Binary Mixtures
 with Double-Diffusive Convection in the Melt", Ph.D.Thesis, Purdue
 University, 1987
- (22) 福迫・山田, "エチレングリコール水溶液凍結挙動", 日本機械学会論文
 集, 55, 502, pp. 3787 3793, 1989
- (23) O.G. Callaghan, E.G. Cravalho & C.E. Huggins, Int. J. Heat
 Mass Transfer, 25, 4, pp. 553, 1982
- (24) 日本海水学会・ソルト・サイエンス研究財団共編, "海水の科学と工業",

東海大學出版社, pp. 28 29

(25) M.W. Kellogg Company, "Saline Water Conversion Engineering Data Book", Office of Saline Water Report, U.S. Department of the Interior, Washington D.C.

(26) 宮坂, 冷凍, 62, 714, pp. 32, 1987

(27) 二瓶, 冷凍, 62, 715, pp. 3, 1987

(28) 白井義人, "凝集氷結晶の生成と海水淡水化への應用", ケミカル・エンジニアリング, 1995

(29) Shirai. Y., Sugimoto. T., Hashimoto. M., Agric. Biol. Chem, 53, pp. 2731, 1987

가